

**TECHNICAL MANUAL OF
SIMTECH UPVC PROFILE**

SIMTECH
UPVC PROFILE

SIMTECH UPVC PROFILES PRIVATE LIMITED

OFFICE ADDRESS: Building No./Flat No.: Kista Reddy Colony
GANDAMGUDA, GANDIPET, Rajendra Nagar, Hyderabad

Rangareddy, Telangana, PIN Code: 500075

Contact No.: 9502135544



Scan QR code
for location



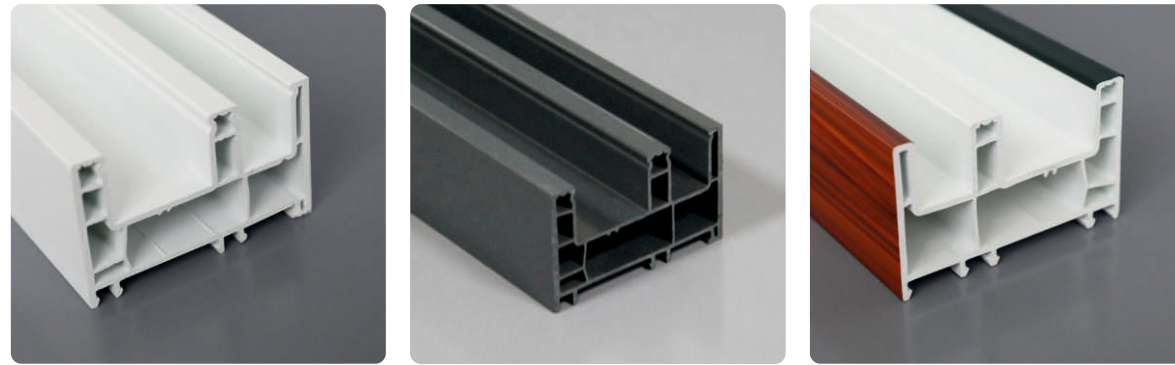

WHITE PROFILE

COLORED PROFILE

FILM LAMINATED PROFILE



LEAD FREE



15 YEARS WARRANTY



High UV RESISTANCE



ISO CERTIFICATION for UPVC PROFILE



RoHS ENVIRONMENT FRIENDLY



FIRE RESISTANCE



ENERGY SAVING

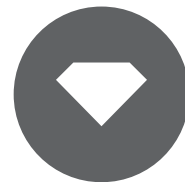

DURABILITY



SAFETY



NOISE REDUCTION



WATER PROOFING



TERMITE PROOF



WIND RESISTANCE

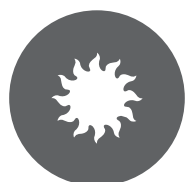

UV RESISTANCE



HUMID PROOF



ECO-FRIENDLY



LIGHT WEIGHT

CONTENTS

01	60 CASEMENT SERIES	01 - 02
02	80 SLIDING SERIES	03 - 04
03	90 SLIDING SERIES	05 - 06
04	112 SLIDING SERIES	07
05	WEIGHT CHART	08 - 09

60 In-Swing Casement Window Technical Drawing

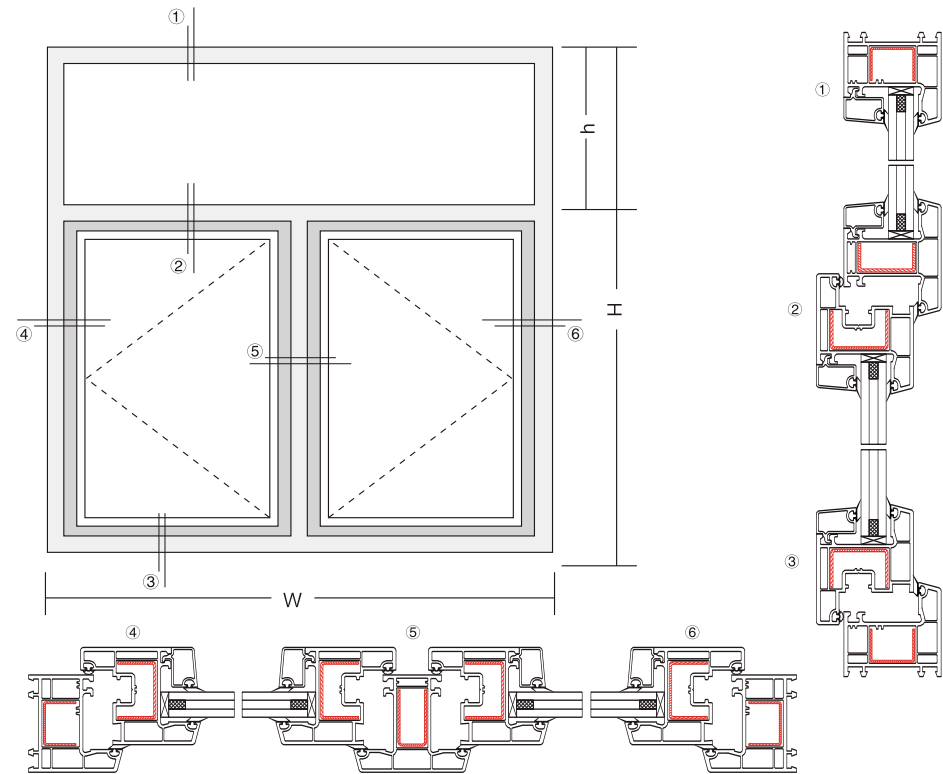

60 Out-Swing Casement Window Technical Drawing

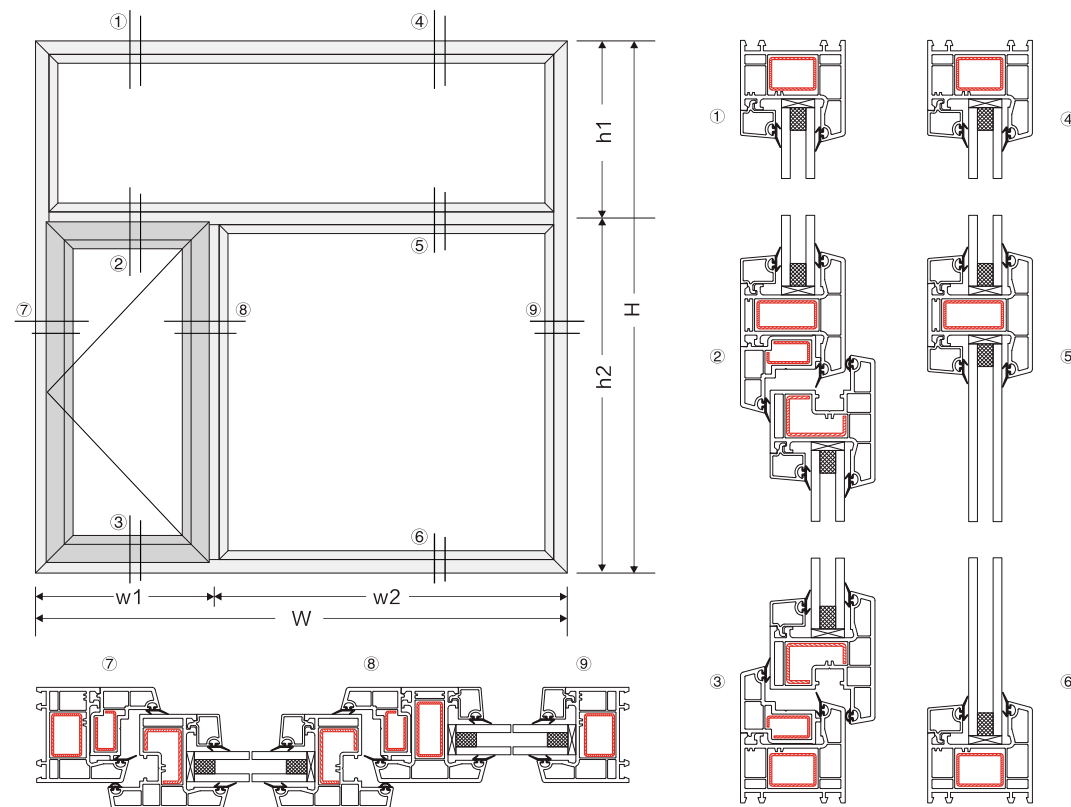

60 Casement Series (Thickness 2.2mm)

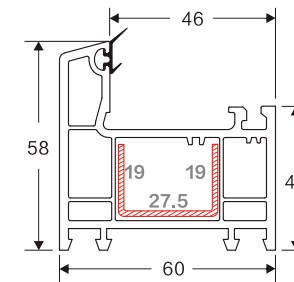

NAME: 60 Frame
WEIGHT (KG/M): 1.04
LENGTH: 5.9 Mtr
PCS/BAG: 6
THICKNESS: 2.2

CODE: ST-CO60R

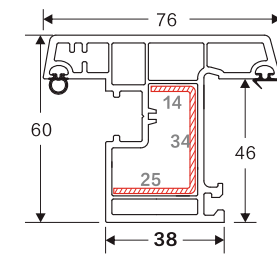

NAME: 60 Out-Swing Window Sash
WEIGHT (KG/M): 1.21
LENGTH: 5.9 Mtr
PCS/BAG: 6
THICKNESS: 2.2

CODE: ST-OWS60R

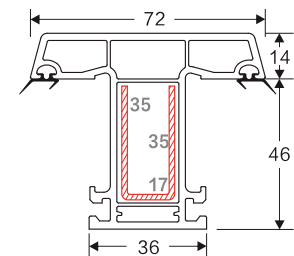

NAME: 60 Mullion D
WEIGHT (KG/M): 1.149
LENGTH: 5.9 Mtr
PCS/BAG: 6
THICKNESS: 2.2

CODE: ST-TM60R

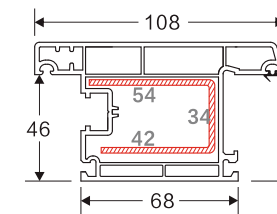

NAME: 60 Out-Swing Door Sash
WEIGHT (KG/M): 1.65
LENGTH: 5.9 Mtr
PCS/BAG: 4
THICKNESS: 2.2

CODE: ST-ODS60R

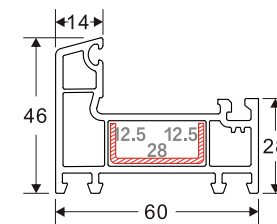

NAME: 60 Small Frame
WEIGHT (KG/M): 0.85 (No Gasket)
LENGTH: 5.9 Mtr
PCS/BAG: 6
THICKNESS: 2.2

CODE: ST-SC60

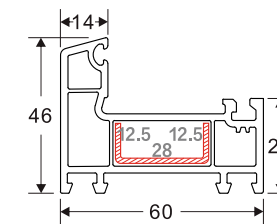

NAME: 60 Small Frame
WEIGHT (KG/M): 0.88 (With Gasket)
LENGTH: 5.9 Mtr
PCS/BAG: 6
THICKNESS: 2.2

CODE: ST-SCO60R

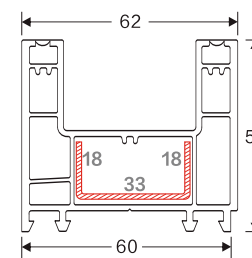

NAME: 60 Double Sliding Frame
WEIGHT (KG/M): 1.098
LENGTH: 5.9 Mtr
PCS/BAG: 6
THICKNESS: 2.2

CODE: ST-2T60

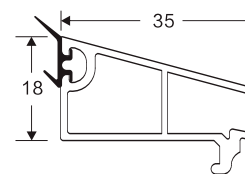

NAME: 60 Single Glazing Bead A
WEIGHT (KG/M): 0.317
LENGTH: 5.9 Mtr
PCS/BAG: 20
THICKNESS: 1.6

CODE: STCGB60R

Glass Thickness: 4.5±0.5mm

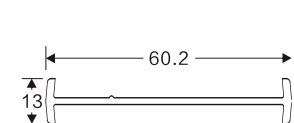

NAME: 60 Flat Board
WEIGHT (KG/M): 0.3
LENGTH: 5.9 Mtr
PCS/BAG: 20
THICKNESS:

CODE: ST-FC60

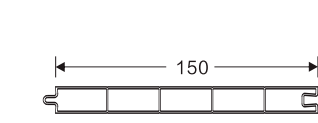

NAME: 150 Door Panel
WEIGHT (KG/M): 0.884
LENGTH: 5.9 Mtr
PCS/BAG: 10
THICKNESS: 1.4

CODE: ST-PB15

80 Sliding Split Type Window Technical Drawing

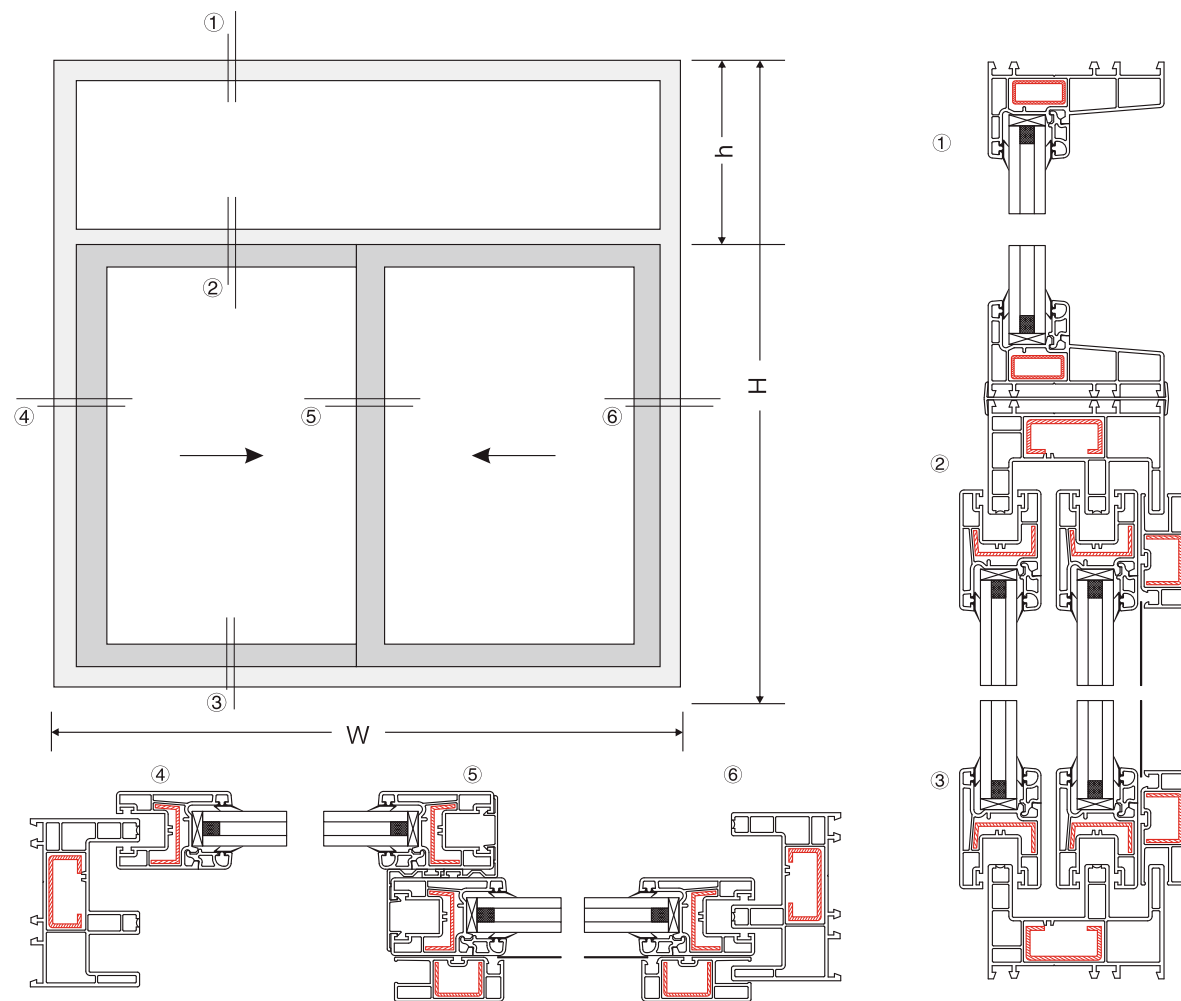

80 Sliding Series (Thickness 2.2mm)

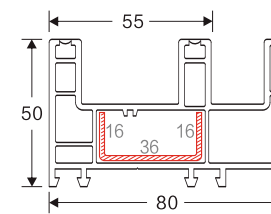

NAME: 80 Sliding Frame
WEIGHT (KG/M): 1.317
LENGTH: 5.9 Mtr
PCS/BAG: 6
THICKNESS: 2.2

CODE: ST-OT80

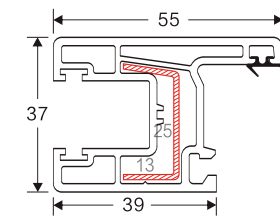

NAME: 80 Sliding Sash
WEIGHT (KG/M): 0.784
LENGTH: 5.9 Mtr
PCS/BAG: 8
THICKNESS: 2.0

CODE: ST-SH80R

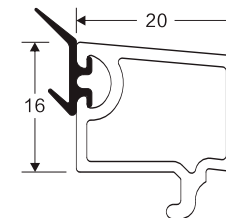

NAME: 80 Glazing bead
WEIGHT (KG/M): 0.22
LENGTH: 5.9 Mtr
PCS/BAG: 30
THICKNESS:

CODE: ST-GB80R

Glass Thickness: 4.5±0.5mm

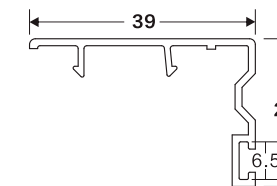

NAME: 80 Glazing Sash Cover
WEIGHT (KG/M): 0.18
LENGTH: 5.9 Mtr
PCS/BAG: 30
THICKNESS:

CODE: ST-IL80

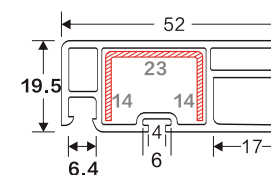

NAME: Screen Sash
WEIGHT (KG/M): 0.492
LENGTH: 5.9 Mtr
PCS/BAG: 15
THICKNESS: 1.7

CODE: SM80

90 Sliding Split Type Window Technical Drawing

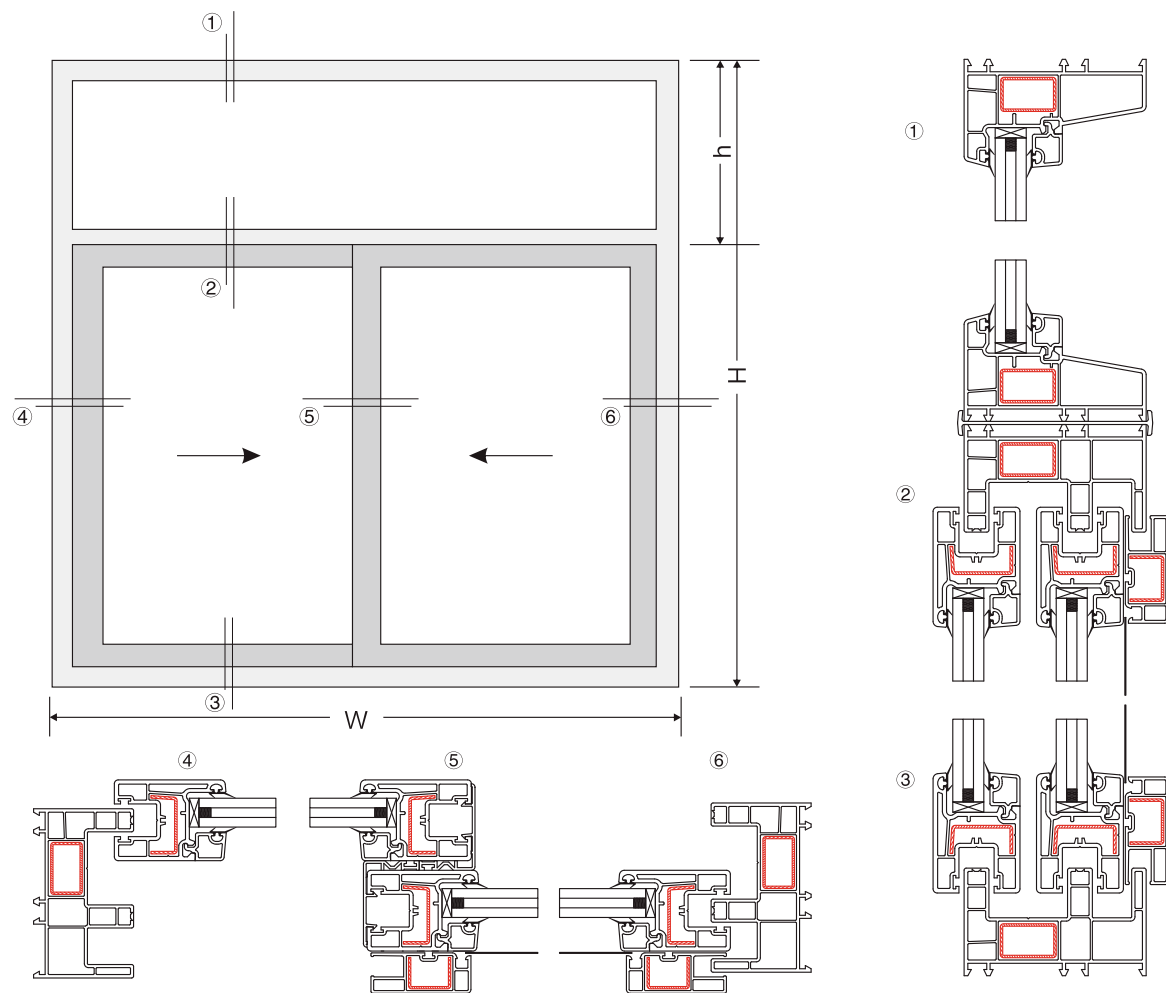

90 Sliding Series (Thickness 2.2mm)

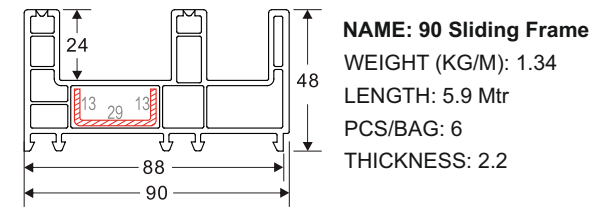

CODE: ST-OT90

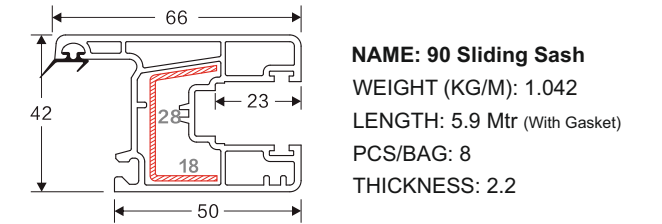

CODE: ST-SH88R

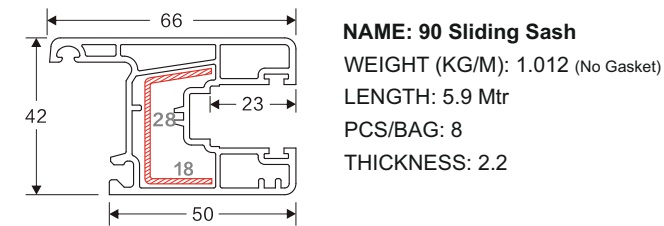

CODE: ST-SH88

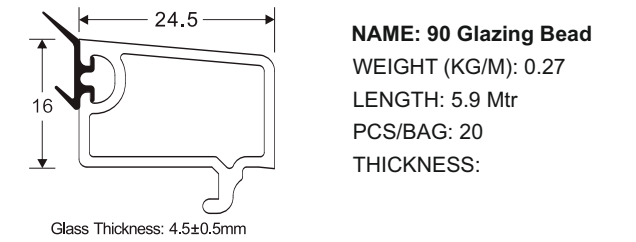

CODE: GB90R

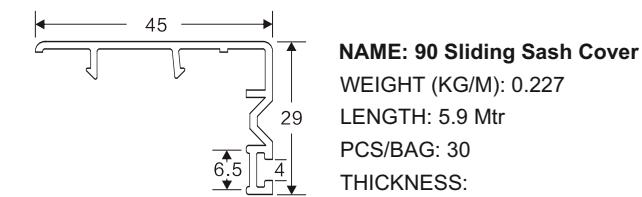

CODE: ST-IL90

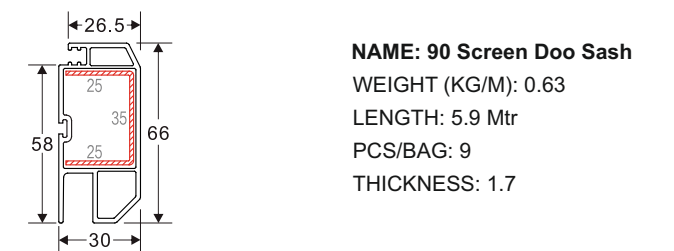

CODE: ST-BM90

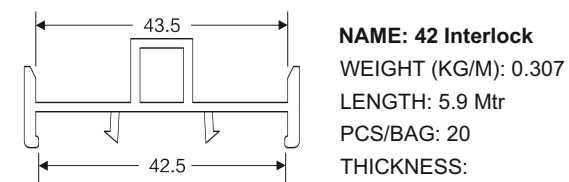

CODE: ST-CP90



CODE: ST-SSM90



CODE: ST-FBC90

112 (3 Track) sliding series (thickness 2.2mm)

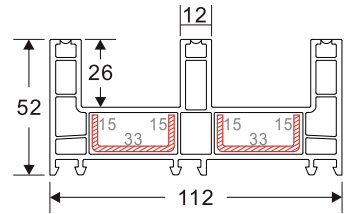

NAME: 112 Sliding Frame
WEIGHT (KG/M): 1.7
LENGTH: 5.9 Mtr
PCS/BAG: 4
THICKNESS: 2.2

CODE: ST-3T112

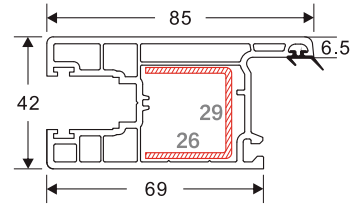

NAME: 60 Sliding Door Sash
WEIGHT (KG/M): 1.25
LENGTH: 5.9 Mtr
PCS/BAG: 4
THICKNESS: 2.2

CODE: ST-SH85R

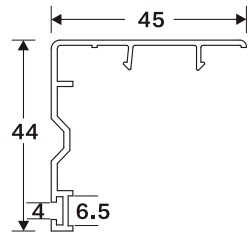

NAME: 60 Sliding Door Sash Cover
WEIGHT (KG/M): 0.217
LENGTH: 5.9 Mtr
PCS/BAG: 20
THICKNESS:

CODE: ST-IL 112

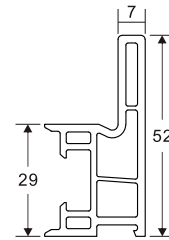

NAME: Mesh Adoptor
WEIGHT (KG/M): 0.54
LENGTH: 5.9 Mtr
PCS/BAG: 10
THICKNESS: 2.2

CODE: ST-MA

SIMTECH UPVC PROFILE

60 CASMENT SYSTEM (Thickness 2.2mm)

S.No	Code	Description	Length (M)	Kg/m	Pcs/Bag	Bags	PCS	Weight	Per PC Wieght
1	ST-OC60R	60B Frame	5.9	1.042	6	1	6	36.89	6.15
2	ST-OWS60R	60B Window Sash	5.9	1.21	6	1	6	42.83	7.14
3	ST-TM60R	60B Mullion	5.9	1.149	6	1	6	40.67	6.78
4	ST-ODS60R	60B Outward door sash	5.9	1.65	4	1	4	38.94	9.74
5	ST-CGB60R	Casement 35mm glazing bead	5.9	0.317	20	1	20	37.41	1.87
6	ST-FC60	Flat Coupling	5.9	0.3	20	1	20	35.40	1.77
7	ST-PB15	15mm Door Panel	5.9	0.884	10	1	10	52.16	5.22
8	ST-SCO60	60B Small Frame	5.9	0.85	6	1	6	31.15	5.19
9	ST-SCO60R	60B Small Frame with gasket	5.9	0.88	6	1	6	34.69	5.78

80 CASMENT SYSTEM (Thickness 2.2mm)

S.No	Code	Description	Length (M)	Kg/m	Pcs/Bag	Bags	PCS	Weight	Per PC Wieght
1	ST-OT80	Standard 80 Frame	5.9	1.317	6	1	6	46.62	7.77
2	ST-SH80R	Standard 55 sash	5.9	0.784	8	1	8	37.00	4.63
3	ST-GB80R	Sliding 20mm Glazing Bead	5.9	0.22	30	1	30	38.94	1.30
4	ST-IL80	80 inter lock	5.9	0.18	30	1	30	31.86	1.06
5	ST-SM80	Small Mesh	5.9	0.492	15	1	15	43.54	2.90

90 CASMENT SYSTEM (Thickness 2.2mm)

S.No	Code	Description	Length (M)	Kg/m	Pcs/Bag	Bags	PCS	Weight	Per PC Wieght
1	ST-OT90	Standard 90 Frame	5.9	1.34	6	1	6	47.44	7.91
2	ST-SH88R	66 High Window Sash	5.9	1.042	8	1	8	49.18	6.15
3	ST-GB90R	Sliding 25mm glazing bead	5.9	0.27	20	1	20	31.86	1.59
4	ST-IL90	90 Interlock	5.9	0.227	30	1	30	40.18	1.34
5	ST-BM90	Big Mesh	5.9	0.635	9	1	9	33.72	3.75
6	ST-CP90	90 Sash Coupling	5.9	0.307	20	1	20	36.23	1.81
7	ST-SSM90	90 Sash Mullion	5.9	0.36	15	1	15	31.86	2.12
8	ST-FBC90	60/90 Flat Board Coupling	5.9	0.3	15	1	15	26.55	1.77

SIMTECH UPVC PROFILE

2 TRACK (Thickness 2.2mm)

S.No	Code	Description	Length (M)	Kg/m	Pcs/Bag	Bags	PCS	Weight	Per PC Wieght
1	ST-2T60	60 High Frame	5.9	1.098	6	1	6	38.87	6.48

112 (3 TRACK) SLIDING SYSTEM (Thickness 2.2mm)

S.No	Code	Description	Length (M)	Kg/m	Pcs/Bag	Bags	PCS	Weight	Per PC Wieght
1	ST-3T112	3 Track Sliding Frame	5.9	1.7	4	1	4	40.12	10.03
2	ST-SH85R	85 High Door Sash	5.9	1.25	4	1	4	29.50	7.38
3	ST-IL112	Interlock	5.9	0.217	20	1	20	25.61	1.28

